

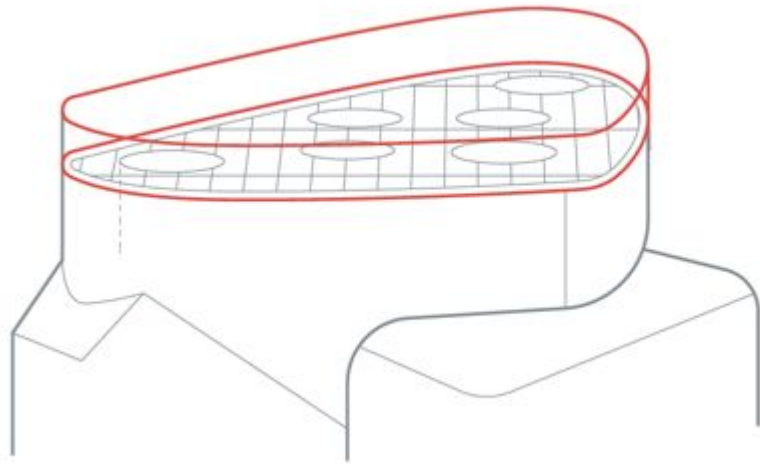

# BMD design guide

## Studio System+

Optimize your design for the full BMD process — printing, debinding, and sintering — to leverage the complete capabilities of the Studio System+



# Table of contents

- 1. Introduction to Bound Metal Deposition™**
- 2. Summary of BMD™ guidelines**
  - a. CAD modeling guidelines
  - b. Fabricate™ model prep guidelines
- 3. Selecting parts for 3D printing**
- 4. BMD considerations and best practices**
  - a. Printing with infill
  - b. Design optimization for printing, debinding and sintering
- 5. Glossary**



## Bound metal deposition

The Studio System™ is a three-part solution that automates metal 3D printing. Tightly integrated through Desktop Metal’s cloud-based software, it delivers a seamless workflow for printing complex metal parts in-house—from digital file to sintered part.

### Print

The Studio printer uses a process called Bound Metal Deposition™ or BMD™. BMD is similar to one of the most widely-used 3D printing technologies, Fused Filament Fabrication, FFF. Instead of filament, the Studio System uses bound metal rods—metal powder held together by wax and polymer binder. The rods are fed through a heated extruder onto the build plate. The printer nozzle shapes the part layer by layer.

### Debind

The printed part, or “green part,” is then placed into the debinder where it is immersed in proprietary debind fluid, dissolving primary binder and creating an open-pore channel structure to prepare the part for sintering.

### Sinter

Then, the part is placed into the furnace where it is heated to temperatures near melting—removing the remaining binder and causing the metal particles to fuse together as the part is sintered. This step necessitates design considerations unique to Bound Metal Deposition because sintering has implications for part features, build orientation, and support structures.

# Summary of BMD guidelines

To fully leverage the advantages of additive manufacturing, it is important to optimize your design for the BMD process — printing, debinding, and sintering. The following guidelines are general recommendations and may not apply to all parts.

## MODELING YOUR PART IN CAD

Standard printhead

**400  $\mu\text{m}$**

High-res printhead

**250  $\mu\text{m}$**

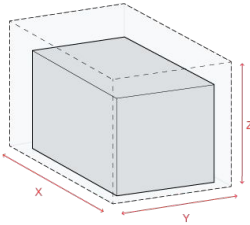

### MAXIMUM PART SIZE

X: 240 mm (9.4 in)  
Y: 150 mm (6.0 in)  
Z: 155 mm (6.1 in)

X: 60 mm (2.4 in)  
Y: 60 mm (2.4 in)  
Z: 60 mm (2.4 in)

The build volume of the Studio printer is 300 x 200 x 200 mm (12 x 8 x 8 in). Due to part shrinkage during sintering, the bounding box for the modeled part is 240 x 150 x 155 mm (9.4 x 6 x 6 in). Fabricate™ scales parts using a scaling factor between 17% and 25%, depending on material. Part geometry may impact maximum part size.

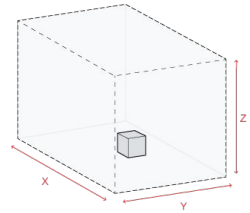

### MINIMUM PART SIZE

X / Y / Z: 6 mm  
(0.24 in)

X / Y / Z: 3 mm  
(0.12 in)

The minimum part size considers the number of bottom layers, top layers, and wall lines required for a successful part.

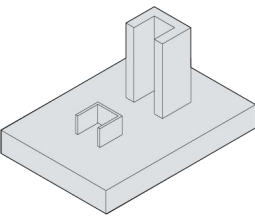

### MINIMUM WALL THICKNESS

**1 mm**  
(0.04 in)

**0.6 mm**  
(0.02 in)

The minimum wall thickness considers structural integrity during printing, debinding, and sintering. Wall thickness must be at least two toolpaths wide.

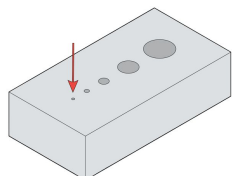

### MINIMUM HOLE SIZE

**1.5 mm**  
(0.06 in)

**0.75 mm**  
(0.03 in)

Similar to most FFF style printers, holes on the Studio System print slightly undersized. To ensure accurate hole size, hole dimensions should be increased by 0.3 – 0.35mm depending on the print orientation. Alternatively, hole dimensions can be left unchanged and machined to the specification.

# Summary of BMD guidelines

## MODELING YOUR PART IN CAD

Standard printhead

High-res printhead

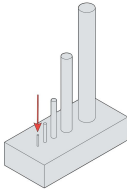
400  $\mu\text{m}$ 250  $\mu\text{m}$ 

### MINIMUM PIN DIAMETER

3 mm  
(0.12 in)1.5 mm  
(0.06 in)

Pins should obey the aspect ratio guideline of 8:1.

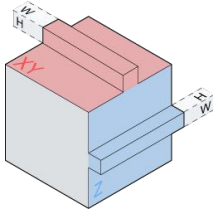

### MINIMUM EMBOSSED FEATURE

**XY** W: 0.45mm (0.018in)  
H: 0.50 mm (0.020in)

W: 0.3 mm (0.012in)  
H: 0.3 mm (0.012in)

**Z** W: 0.25 mm (0.01in)  
H: 0.50 mm (0.02 in)

W: 0.15 mm (0.006in)  
H: 0.30 mm (0.012 in)

Embossed features appear in relief on the surface of the model. If an embossed feature is too thin, it likely will not print.

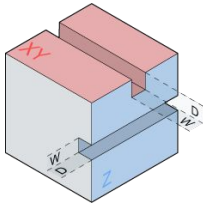

### MINIMUM ENGRAVED FEATURE

**XY** W: 0.25 mm (0.01in)  
D: 0.50 mm (0.02 in)

W: 0.3 mm (0.012in)  
H: 0.3 mm (0.012in)

**Z** W: 0.50 mm (0.02 in)  
D: 0.45 mm (0.018in)

W: 0.15 mm (0.006 in)  
H: 0.30 mm (0.012 in)

Engraved features are typically used for detailing and text on the surface of the model. If an engraved feature is too thin, it risks being filled in during printing.

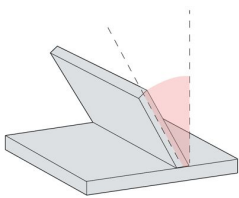

### MINIMUM UNSUPPORTED OVERHANG ANGLE

40°

40°

Overhangs greater than 40° from vertical will require supports. Supports are important during printing, but are most critical during sintering. While the printing process can tolerate a 40° overhang, sintering may tolerate much less. It will depend on the geometry, but one should avoid cantilevered masses, and small features that cause the entire part to sit on top of support.

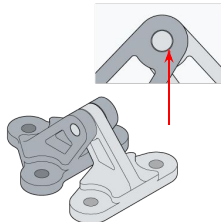

### MINIMUM CLEARANCE

0.3 mm  
(0.012 in)0.2 mm  
(0.008 in)

The additive nature of 3D printing enables the fabrication of multiple parts as printed in-place assemblies with moving or embedded parts. Interlocking components of a moving assembly should have 0.3mm (0.011in) of clearance.

# Summary of BMD guidelines

## MODELING YOUR PART IN CAD

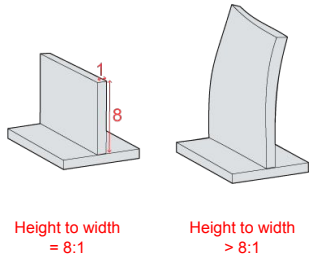

ASPECT RATIO (height : width)

Standard printhead  
400  $\mu\text{m}$

High-res printhead  
250  $\mu\text{m}$

8:1

8:1

Unsupported tall, thin features are challenging for debind and sintering processes and should be limited when possible. The ratio of height to width for tall walls or pillars should not exceed 8:1. Tall cylinders and walls are the least stable geometries.

## PREPARING YOUR MODEL IN FABRICATE™

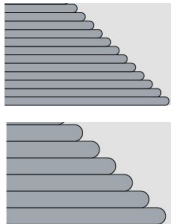

LAYER HEIGHT

150  $\mu\text{m}$  - 200  $\mu\text{m}$

50  $\mu\text{m}$

Larger layer heights allow for faster print times, but there is a tradeoff between print time and surface quality. Parts with fine features are better suited to a finer layer height to ensure that small features are accurately printed. Larger parts can make use of the coarse profile to ensure fast print times

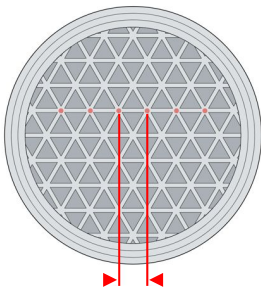

INFILL LINE SPACING

2.8 mm  
(0.11 in)

1.75 mm  
(0.07 in)

In Fabricate™, the default setting for **infill line spacing** is 2.8 mm for the standard print head and 1.75mm for the high-res printhead.

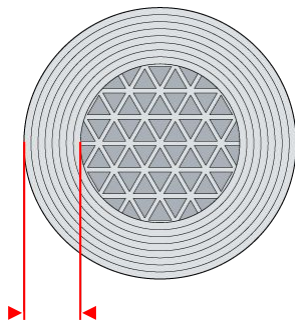

MAXIMUM SHELL THICKNESS

4 mm (0.16 in)  
Part with infill

4 mm (0.16 in)  
Part with infill

10 mm (0.4 in)  
Part without infill

10 mm (0.4 in)  
Part without infill

Together, the part's walls, top layers, and bottom layers comprise the part shell. The limit to shell thickness is the debind process. Debind duration is a function of overall cross-sectional thickness. Parts with thick walls will take longer to debind. To prevent excessively long debind time, keep shell thickness under 4mm.

# Selecting parts for BMD

Additive manufacturing and the Studio System open up new capabilities for producing metal parts. However, not all parts make sense to 3D print and oftentimes simple geometries or parts produced in high volumes are more cost-effective to produce with other technologies. Part geometry, economics, and performance are important factors tied to the fabrication method.

## Selecting parts for BMD

Evaluate parts across applications. Begin by selecting custom parts, low-volume parts, complex parts, and parts with long lead times. Use the decision funnel to eliminate parts based on the following characteristics.

Custom / low volume parts / long lead

Size / geometry

Fabrication time

Cost

BMD parts

As you evaluate parts for BMD, review a wide range parts - keep in mind your objective and use the decision funnel (left) to downselect parts best suited to the process. To begin, identify **custom** parts, **low-volume** parts, **complex** parts, and parts with **long lead times**. Eliminate parts not appropriate based on **size** and/or **geometry** and that cannot be modified to follow the BMD design guidelines. Use estimates for BMD™ **fabrication time** and part **cost** to eliminate parts for which BMD is not cost- competitive or does not reduce fabrication time. Benchmark the selected parts to evaluate part **performance**.

When selecting parts for BMD™, it is important to keep in mind that existing parts were likely designed for another fabrication process. There may be value in producing these parts on the Studio System without design modifications - in fact, this is what most people do when they start using the System. However, simply replicating a design subjects the part to the restrictions of the 3D printing process whereas adapting or optimizing your design for BMD™ allows you to capture the benefits of 3D printing.

## Estimating part cost

Build media, debind fluid, furnace gas, and electricity are the largest drivers of part cost.

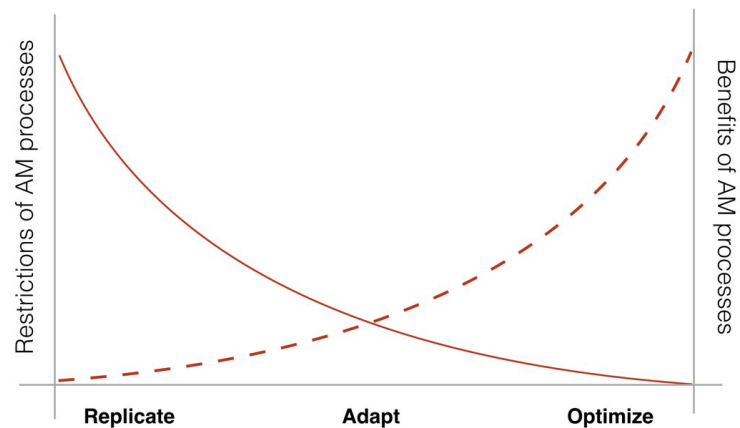
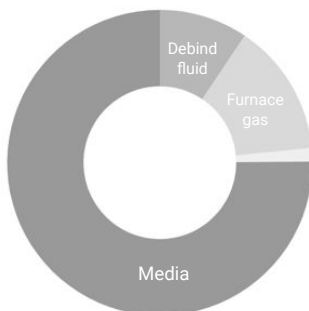

**Cost estimates** are essential for selecting parts for fabrication on the Studio System. Upload your design file to Fabricate™ to view estimates for media costs (metal and ceramic), as well as estimated print, debind, and sintering times. Depending on the way your organization calculates ROI, other costs like equipment, energy, service, and consumables, may be important to take into account.

# Considerations and best practices

## The anatomy of the printed part

The bottom layer, top layer, and walls comprise the part's "shell." The closed-cell infill makes up the interior of the part.

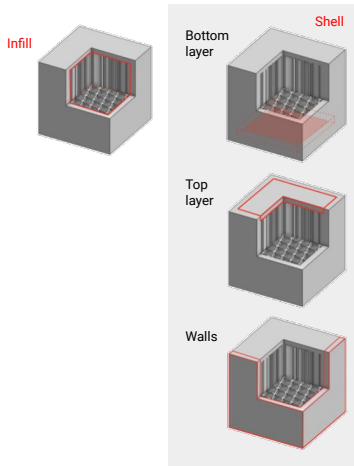

## Carriage

The carriage part shown below. Printing the part with infill (lower left) reduces the fabrication time, material cost, and part mass.

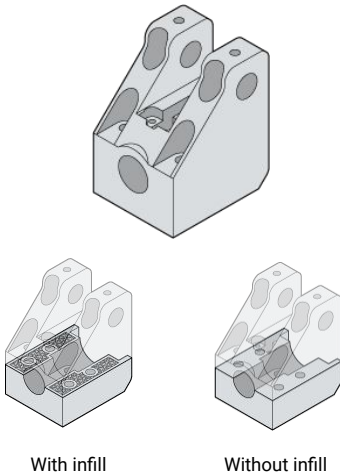

## Printing with infill

### The role of infill

Similar to parts printed using fused filament fabrication (FFF), most parts printed with the Studio System contain infill. Infill describes the internal lattice structure printed throughout the part, enclosed by the solid walls that make up the shell of the part—creating what is called, **closed-cell infill**. The ability to lightweight parts with infill is a key advantage with additive manufacturing (AM). Using subtractive processes, you must redesign the exterior of the part or select a lighter-weight material in order to reduce overall part weight. The top and bottom layers are printed solid (without infill), while the middle layers are printed with solid outer walls and the triangular infill pattern making up the interior structure.

### Infill & fabrication time

The use of infill reduces the amount of material and time required to print a part. It also reduces the debind cycle time, which depends on the cross-sectional thickness (wall thickness + lines of infill to the center of the part). A solid part will take much longer to debind and sinter, or it might not fully debind which can lead to serious part defects like cracking.

Carriage - sample part	Carriage with infill	Carriage without infill	Savings due to infill
Print time (hours)	7	11	36%
Debind time (hours)	19	50	62%
Total fabrication time (hours)	67	100	33%
Material (g)	170	280	40%
Cost of material	\$20	\$33	40%
Final part mass (g)	118	220	46%

### Infill and part strength

In combination with the outside shell, infill-based structures feature excellent rigidity at minimal weight. The shape of the infill geometry has a significant impact on both the effective modulus and the degree of anisotropy of structural properties. The Studio Printer prints with triangular infill, which offers several benefits over hexagonal or square infill geometries. Triangular infill results in a constant elastic modulus in the X-Y plane, ranging from 18-28% of the solid material's elastic modulus.



# Considerations and best practices

## Optimizing for printing, debinding, and sintering

### Strategies for reducing debind time

During the debinding process, the part is fully immersed in debind fluid. The debind fluid is a solvent that dissolves the wax portion of the binder to create an open-pore structure in the part allowing the remainder of the polymer binder to escape during sintering. The debind fluid surrounding the part must diffuse through the printed material until it reaches the center of the part. The distance that the fluid travels from the outer wall to the part center is known as the cross-sectional thickness. Fabricate uses the cross-sectional thickness to calculate debind time.

#### Cross-sectional thickness

The cross-sectional thickness is equal to the wall thickness plus the lines of infill to the center of the part.

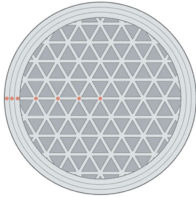

#### Tip 1

Reduce the cross-sectional thickness to shorten the debind time. For the example part, below, a cylindrical core has been removed.

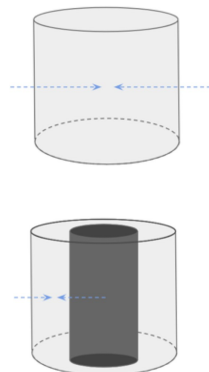

Debind time is impacted by the wall thickness of the part. To illustrate this point, consider a cross-section of the part. The cross-section reveals the wall lines (the perimeters of the circle) and the lines of triangular closed-cell infill. Debind fluid flows freely between in the voids created by the infill, but dissolves slowly through the solid material of the wall lines and each line of infill. Increasing wall line count leads to an increase in the length of the debind cycle.

#### Tip 1 [using CAD]: Reduce the cross-sectional thickness to shorten the debind time.

Identify opportunities to modify your part design to reduce the **cross-sectional thickness**. One approach is to remove or 'core' thick sections of the part (similarly, you can add large depressions to thick sections of the part). For the example part, a cylindrical core has been removed (3). Now debind fluid can enter the part through the outer and inner walls. The distance to the center of the thick region of the part is, very noticeably, much smaller.

#### Coring example: mold insert

Coring the mold insert reduced the debind time by 3.5X and 14X, depending on the design approach.

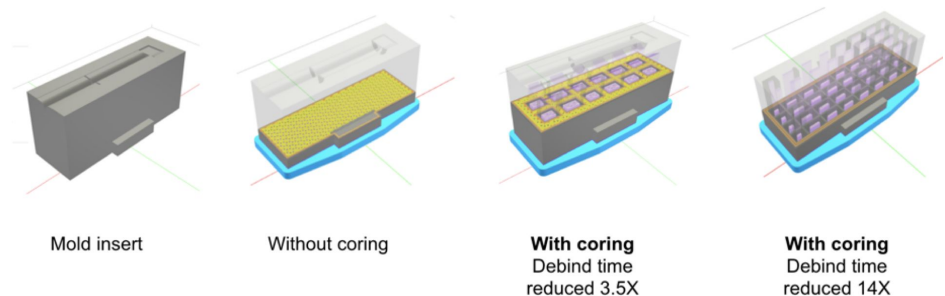

**Tip 2 [using Fabricate]:** Fabricate's default setting for **wall line count**, **top layer**, and **bottom layer** balance part strength and debind time. Increasing **wall line count**, **top layer**, and **bottom layer** in Fabricate's advanced settings can increase part strength, but will lead to longer debind times.

# Considerations and best practices

## Optimizing for printing, debinding, and sintering

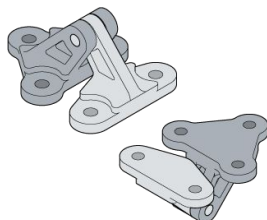

### PRINT ORIENTATION

Part orientation must be the same for printing, debinding, and sintering. Select an orientation that optimizes for *full process* success. The way you choose to orient your part during printing has implications for support material usage, surface quality, and fabrication time. When orienting your part, consider the following:

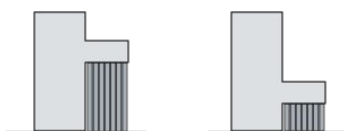

#### Minimize support volume

Minimize support volume to save print time and material. Avoid large overhanging portions of your part that rest on support structures.



#### Avoid high centers of gravity

Avoid orientations that elevate the part's center of gravity.



#### Avoid critical surfaces contacting supports

Surfaces in contact with support structures will have rougher surface quality. It is best to avoid having critical surfaces contact support structures.

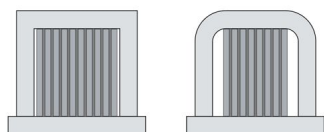

### FILLET SHARP INSIDE CORNERS

Sharp corners can concentrate stress in the part and increase the risk of cracking during sintering. Whenever possible, add a fillet to sharp corner.

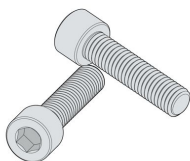

### AVOID PRINTING HARDWARE

Unless you are prototyping hardware, it rarely makes sense to print metal parts like screws or hinge pins. Purchasing off-the-shelf parts is typically less expensive. In general, be strategic and think about the cost and benefit of printing parts.

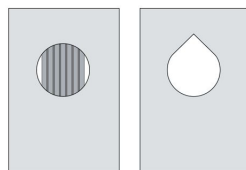

### MAKE HOLES SELF-SUPPORTING

For horizontal holes of certain diameters supports may not be necessary, but Fabricate automatically generates supports. Users can avoid using support structures for horizontal holes by redesigning the circular hole shape into a teardrop or diamond shape, which utilizes a self-supporting angle. The self-supporting angle eliminates the need for supports.

# Considerations and best practices

## Optimizing for printing, debinding, and sintering

### PRINTED THREADS

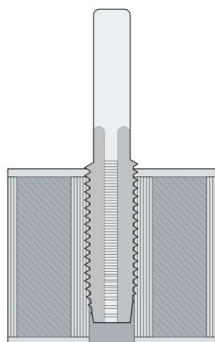

For many 3D printing methods, including laser powder-bed fusion, it is recommended printing holes and then tapping threads. With the Studio System, it is recommended that users tap threads for thread sizes M3 to M9. For threads M10 and larger, print the threads and chase them with a die. When tapping threads, increase the wall line count from the default of 3 lines to 5-7 lines to ensure sufficient material. For threads M10 and larger, printing and chasing will produce the best results.

Thread size	Method
< M10	Print hole, tap threads
≥ M10	Print threads, chase threads

### CUP-SHAPED PARTS

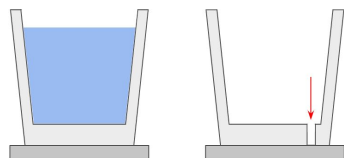

During the debinding process, the entire part is immersed in debind fluid. After debinding is complete, the fluid drains from the processing tank and is distilled for re-use in the next run. Parts with a “cup” shape or with large depressions or cavities (approximately 8 cm<sup>3</sup> or greater), will hold debind fluid and prevent the part from drying completely.

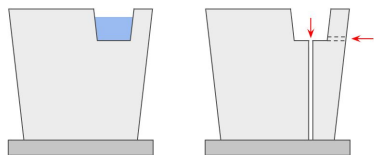

In some cases, re-orienting the part may address the issue. However, keep in mind that part orientation must be the same for printing, debinding, and sintering. Select an orientation to optimize for *full process* success. For the example part shown above, it is **not** recommended to print the cup-shaped part with the cavity facing upward and then invert the part for debinding. Neither is it recommended to invert this cup-shaped part for printing, debinding, and sintering. While inverting the cup-shaped part would solve the issue of the part holding debind fluid, it would mean printing supports beneath the cup leading to a lengthier print time and a riskier sintering process.

Simple modifications can be made to parts to ensure that all of the debind fluid drains from the part. **Adding small drainage holes (as small as 1mm) to your part design will allow the fluid to drain.** Note: the raft will not block the drainage holes. The raft is printed with space between beads of material, which allows the debind fluid to drain quickly through it.

### CLEARANCES

#### Printed-in-places assemblies

For components of a moving assembly, clearance of 0.3 mm (0.012 in) clearance is recommended between components. *Shown left.*

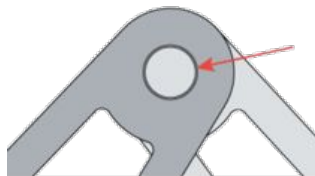

#### Close fit

For components to mate after sintering, a larger clearance of 0.3 mm to 0.6 mm (0.012 - 0.024 in) is recommended. *Shown right.*

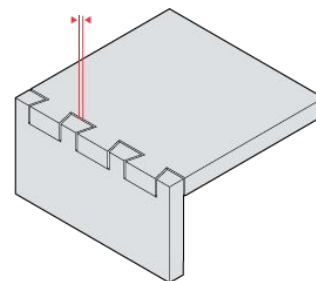

# Considerations and best practices

## DEEP DIVE:

### Optimizing for printing, debinding, and sintering

#### SUPPORTS

The interface layer plays a very important role in the BMD part fabrication process. During the furnace cycle, the interface layer becomes a powder that physically keeps the part from sintering to the support structures. This is what enables Separable Supports™ and the significant benefit of allowing users to remove support structures by hand. However, for some geometries, the fact that support structures are not strongly attached to parts during the sintering process may mean that parts can shift or separate from supports during the sintering process.

One specific example is a feature that sits at an angle atop a support structure. In the “unstable part” example (shown below), the feature wants to shift to the left during the sintering process. To prevent the part from shifting or sliding, the Fabricate setting for **support overhang angle** has been modified to a lower angle, causing supports to build to the left of the feature. This support structure will now “cradle” the part during sintering, preventing the part from shifting.

#### Example 1

**Tip:** Adjust the support angle to a lower angle, which will cause supports to build to the left of the feature. The support structure will now “cradle” the part during sintering, preventing the part from shifting.

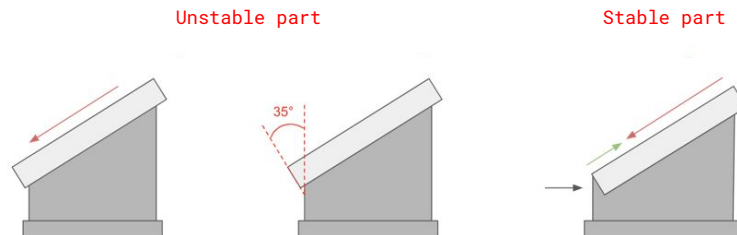

User-defined parts/features are not the only structures that can shift during the sintering process. Support structures may also shift during the sintering process. Support structures that have a flat base will remain stable during sintering process. However, when a support structure has an angled base, the support will want to slide away from that part that it is supporting. This situation should be avoided. In order to avoid this situation, the original part geometry can be modified. Adding a small lip or bump to the part where it contacts the bottom of the support structure will prevent the support structure from shifting during sintering.

#### Example 2

**Tip:** If you notice that Fabricate is generating supports with an angled base, consider modifying your design in CAD. Add a small lip or bump to the part where it contacts the bottom of the support structure.

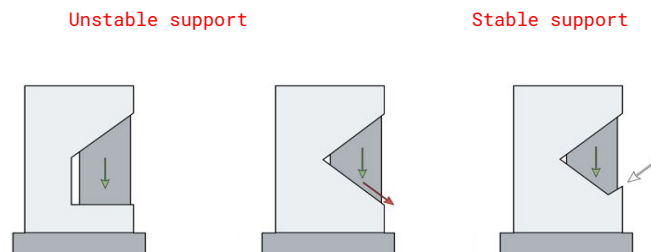

# Considerations and best practices

## DEEP DIVE:

### Optimizing for printing, debinding, and sintering

#### ASPECT RATIO

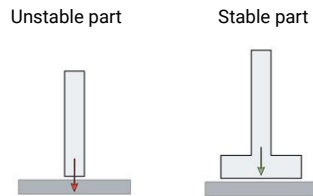

The most slender vertical cylinder that can be printed, debound, and sintered has an aspect ratio of 8:1 (height : diameter) and is attached to a larger base - rather than being a free-standing feature. If the slender cylinder is a free-standing feature and sits directly on the raft instead of being attached to a part, the cylinder will be less stable. This is because the cylinder will sit directly on the ceramic interface layer, which turns to a powder during the sintering process, creating an unstable base for the cylinder to sit on. For free-standing cylinders, the aspect ratio of the feature should be reduced by 40% to about 5:1.

Most features and parts are **not** perfect vertical cylinders. In these cases, it is important to note where the center of gravity of the feature is located. Features are most stable when the center of mass is sitting above the base of the feature. A less stable feature is one where the center of mass is not vertically supported. An example is a tall pillar on a slight angle (shown below). During sintering, when the material is weak, the feature will want to fall over.

Unstable part

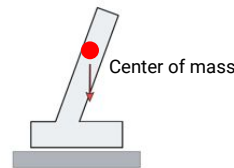

Stable part

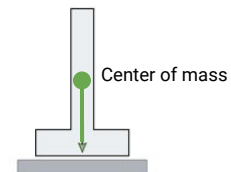

#### Solution 1

Attach the overhanging feature to a larger, more stable part. In this instance, the center of mass has now been moved to a location above the base of the feature.

There are a few options for addressing features whose center of mass does not sit above the base of the features. Through modifications to the original geometry, stable features can be created. The first solution is to attach the overhanging feature to a larger, more stable part. In this instance, the center of mass has now been moved to a location above the base of the feature. Another solution is to add support ribs, pillars, or other features. When adding supporting features, attach them to the original feature in a manner that will support the part during sintering. It is good practice to ensure that the center of mass is located within the bounds of the base of the original feature and support features.

#### Solution 2

Add support ribs, pillars, or other features. When adding supporting features, attach them to the original feature in a manner that will support the part during sintering.

Solution 1

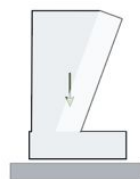

Solution 2

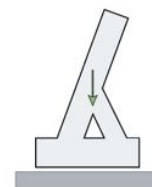

# Glossary

**Studio System printer / Studio printer / printer:** Desktop Metal's office-friendly metal 3D printer

**Studio System debinder / Studio debinder / debinder:** Desktop Metal's office-friendly debinder; immerses the part to remove binding material, creating an open-pore structure in preparation for sintering

**Studio System furnace / Studio furnace / furnace:** Desktop Metal's office-friendly sintering furnace; sinters the part to remove remaining binder and produce a metal part with densities between 96-99.8% (depending on the material)

**Fabricate™:** Desktop Metal software

**Separable Supports™:** Technology in which parts are easily separated from their support structures due to a Ceramic Release Layer (or interface layer)

**Studio materials:** Metal materials available for the Studio system; specially-formulated bound metal rods

**17-4 PH media cartridge:** Metal particles mixed in a plastic binder. This is the material that is printed and forms the final metal part.

**Interface media cartridge:** Ceramic particles mixed in a plastic binder. Used to keep support structures from sintering to the part in the furnace

**Green part:** The state of the part after printing, before debinding

**Brown part:** The state of the part after debinding, before sintering

**Sintered part:** The state of the part after sintering

**Print sheet:** Polypropylene sheet that the part is printed on top of. The sheet is peeled from the part after printing. Sheets are designed to be single use.

**Debind fluid:** Solvent that is used to debind studio system parts - see the SDS for more information

**Gas no. 1:** Gas that is used in the furnace during the sintering cycle to sinter specific materials, including 17-4 PH. Ensures an inert environment during sintering.